

Compact Disc Player

Operating Instructions





CDP-CX335

WARNING

To prevent fire or shock hazard, do not expose the unit to rain or moisture.

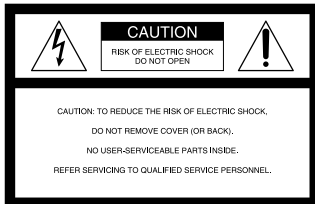
To avoid electrical shock, do not open the cabinet. Refer servicing to qualified personnel only. Do not install the appliance in a confined space, such as a bookcase or built-in cabinet.



 This symbol is intended to alert the user to the presence of uninsulated “dangerous voltage” within the product’s enclosure that may be of sufficient magnitude to constitute a risk of electric shock to persons.

 This symbol is intended to alert the user to the presence of important operating and maintenance (servicing) instructions in the literature accompanying the appliance.

INFORMATION

This equipment has been tested and found to comply with the limits for a Class B digital device, pursuant to Part 15 of the FCC Rules. These limits are designed to provide reasonable protection against harmful interference in a residential installation. This equipment generates, uses, and can radiate radio frequency energy and, if not installed and used in accordance with the instructions, may cause harmful interference to radio communications. However, there is no guarantee that interference will not occur in a particular installation. If this equipment does cause harmful interference to radio or television reception, which can be determined by turning the equipment off and on, the user is encouraged to try to correct the interference by one or more of the following measures:

- Reorient or relocate the receiving antenna.
- Increase the separation between the equipment and receiver.
- Connect the equipment into an outlet on a circuit different from that to which the receiver is connected.
- Consult the dealer or an experienced radio/TV technician for help.

CAUTION

You are cautioned that any changes or modification not expressly approved in this manual could void your authority to operate this equipment.

Owner’s Record

The model and serial numbers are located at the rear of the unit. Record the serial number in the space provided below. Refer to them whenever you call upon your Sony dealer regarding this product.

Model No. CDP-CX335

Serial No. _____



ENERGY STAR® is a U.S. registered mark. As ENERGY STAR® Partner, Sony Corporation has determined that this product meets the ENERGY STAR® guidelines for energy efficiency.

Welcome!

Thank you for purchasing the Sony Compact Disc Player. Before operating the unit, please read this manual thoroughly and retain it for future reference.

About This Manual

The instructions in this manual are for model CDP-CX335.

Conventions

- Instructions in this manual describe the controls on the player. You can also use the controls on the remote if they have the same or similar names as those on the player.
- The following icons are used in this manual:



Indicates that you can do the task using the remote.



Indicates hints and tips for making the task easier.

TABLE OF CONTENTS

Getting Started

| | |
|------------------------------------|---|
| Unpacking | 4 |
| Hooking Up the System | 4 |
| Connecting Another CD Player | 6 |
| Inserting CDs | 7 |

| | |
|--------------------|----|
| Playing a CD | 10 |
|--------------------|----|

Playing CDs

| | |
|---|----|
| Using the Display | 12 |
| Locating a Specific Disc | 14 |
| Specifying the Next Disc to Play | 15 |
| Playing the Disc Which was Just Inserted – Easy Play | 15 |
| Locating a Specific Track or a Point in a Track | 16 |
| Playing Repeatedly | 17 |
| Playing in Random Order (Shuffle Play) | 17 |
| Creating Your Own Program (Program Play) | 18 |
| Playing Using a Timer | 20 |
| Controlling Another CD Player (Advanced Mega Control) | 21 |
| Fading In or Out | 22 |
| Playing Alternately (No-Delay Play/X-Fade Play) | 23 |
| Controlling the Player from Another unit | 23 |

Storing Information About CDs (Custom Files)

| | |
|--|----|
| What You Can Do With the Custom Files | 24 |
| Labeling Discs (Disc Memo) | 24 |
| Storing Custom File Information Using a keyboard | 27 |
| Storing Specific Tracks (Delete Bank) | 28 |
| Grouping Discs (Group File) | 28 |
| Storing Your Favorite Tracks (Hit List) | 30 |

Additional Information

| | |
|-----------------------|----|
| Precautions | 32 |
| Notes on CDs | 32 |
| Troubleshooting | 33 |
| Specifications | 33 |

| | |
|-------------|----|
| Index | 34 |
|-------------|----|

Unpacking

Check that you received the following items:

- Audio cord (1)
- Remote commander (remote) (1)
- Size AA (R6) batteries (2)

Inserting batteries into the remote

You can control the player using the supplied remote. Insert two size AA (R6) batteries (supplied) by matching the + and - on the batteries to the diagram inside the battery compartment.

Insert the negative (-) end first, then push in and down until the positive (+) end clicks into position.

When using the remote, point it at the remote sensor  on the player.

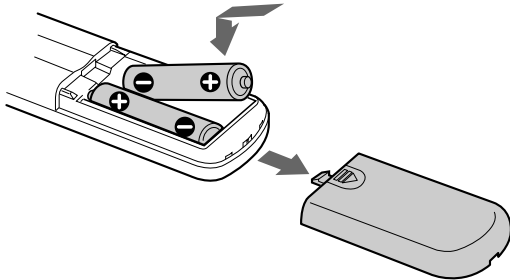

When to replace batteries

With normal use, the batteries should last for about six months. When the remote no longer operates the player, replace all the batteries with new ones.

Notes

- Do not leave the remote near an extremely hot or humid place.
- Do not drop any foreign object into the remote casing, particularly when replacing the batteries.
- Do not expose the remote sensor to direct sunlight or lighting apparatuses. Doing so may cause a malfunction.
- If you do not use the remote for an extended period of time, remove the batteries to avoid possible damage from battery leakage and corrosion.

Hooking Up the System

Overview

This section describes how to hook up the CD player to an amplifier. Be sure to turn off the power of each component before making the connections.

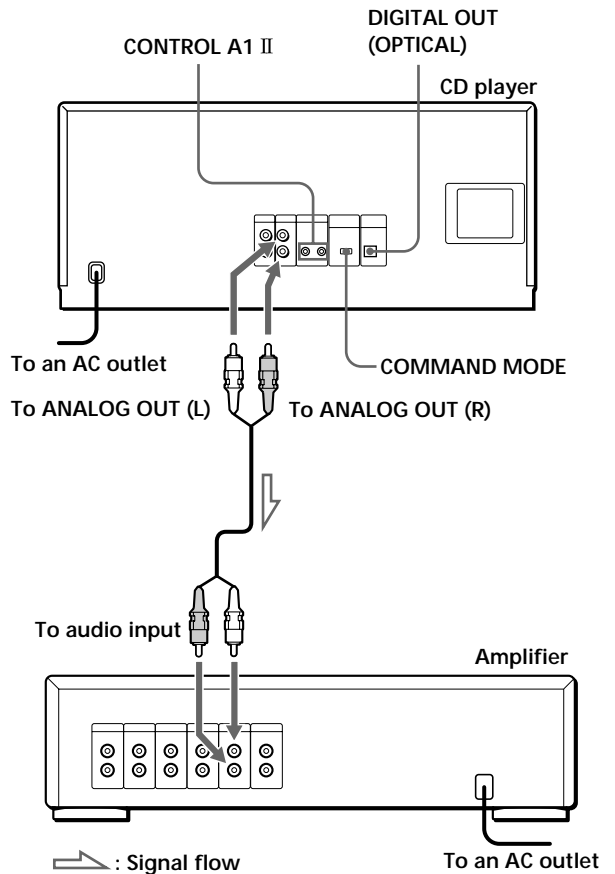

What cords will I need?

Audio cord (1) (supplied)

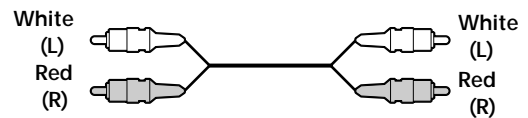

Hookups

When connecting the audio cord, be sure to match the color-coded cord to the appropriate jacks on the components: Red (right) to Red and White (left) to White. Be sure to make connections firmly to avoid hum and noise.

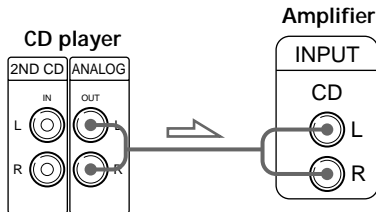

- **If you have a digital component such as a digital amplifier, D/A converter, DAT or MD**

Connect the component via the DIGITAL OUT (OPTICAL) connector using an optical cable (not supplied). Take off the cap and plug in the optical cable.

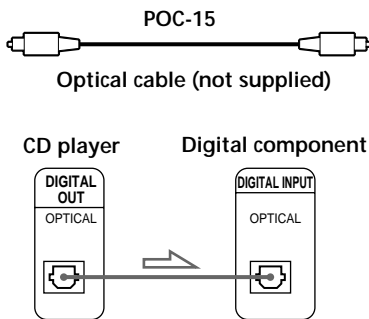

Note

When you connect via the DIGITAL OUT (OPTICAL) connector, noise may occur when you play CD software other than music, such as a CD-ROM.

- **If you have a Sony component with the CONTROL A1 II jack**

Connect the component via the CONTROL A1 II jack. You can simplify the operation of audio systems composed of separate Sony components. For details, refer to the supplementary "CONTROL A1 II Control System" instructions.

- **When using another Sony CD player together with this player**

You can make the supplied remote effective only for this player.

- When using the player equipped with the COMMAND MODE selector: Set the COMMAND MODE selector of this player to CD 1 and that of another player to CD 2 or CD 3. Then set the CD 1/2/3 switch on the remote supplied for each player accordingly.
- When using the player not equipped with the COMMAND MODE selector: The command mode of the player without the COMMAND MODE selector is set to CD 1. Set the COMMAND MODE selector of this player to CD 2, and set the CD 1/2/3 switch on the remote to CD 2.

Connecting the AC power cord

Connect the AC power cord to a wall outlet.

Note on placement

Be sure to place the player on a horizontal place. If the player is slanted, it may cause malfunction or damage the player.

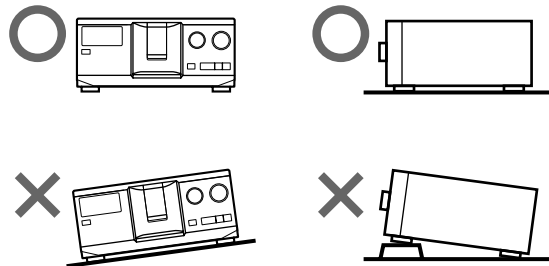

Connecting Another CD Player

If you have a Sony CD player in which 5, 50, 200, or 300 discs can be inserted and which is equipped with the CONTROL A1 II (or CONTROL A1) jack and the command mode of that player can be set to CD 3, you can control that player as the second player with this unit. After connecting this unit and an amplifier, follow the procedure below.

Be sure to turn off the power of each player before making this connection.

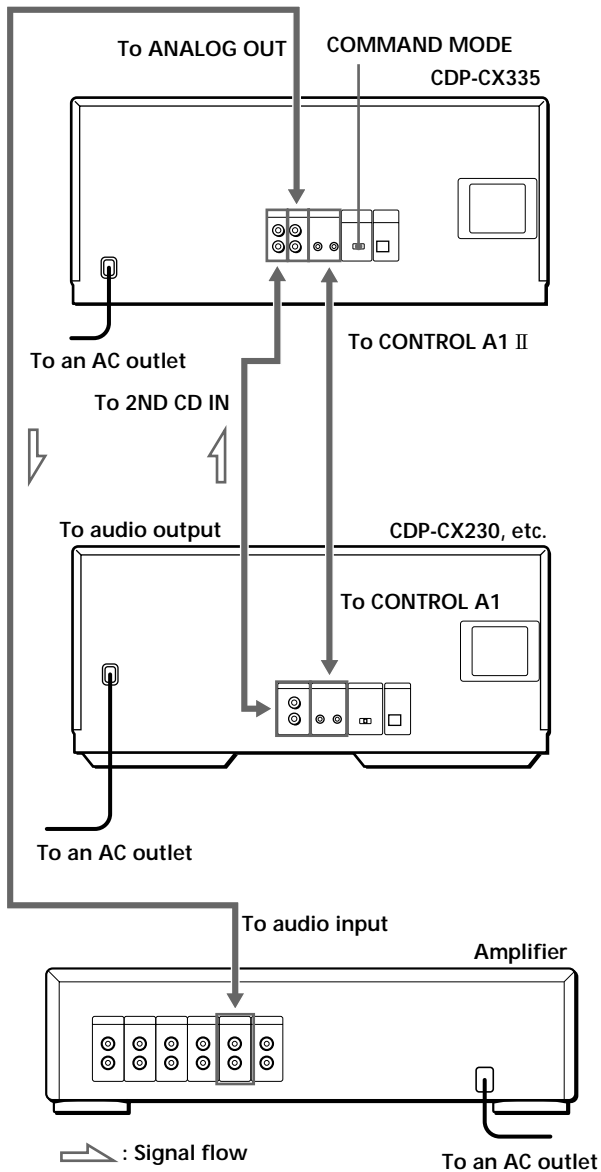

What cords will I need?

- Audio cord (1) (Use the cord supplied with the player to be connected.)
- Monaural (2P) mini-plug cord (1) (not supplied)

- 1 Connect the players with an audio cord (see also "Hookups" on page 5).

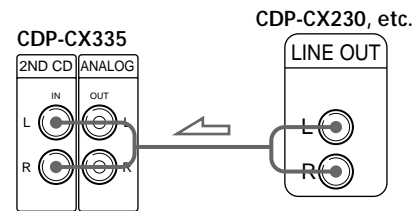

- 2 Connect the players with a monaural (2P) mini-plug cord.

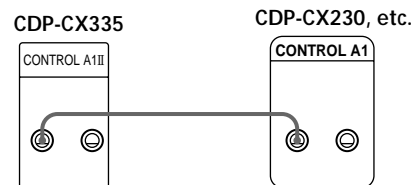

For details on this connection, refer to the supplementary "CONTROL A1 II Control System" instructions.

- 3 Set the COMMAND MODE selector of this player to CD 1 or CD 2, and set the command mode of the second player to CD 3.

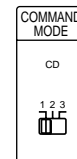

For details on how to operate the second player, see "Controlling Another CD Player" on page 21 and "Playing Alternately" on page 23.

- 4 Connect the AC power cord of both players to AC outlets.

Notes

- Do not connect a player other than that you intend to use as the second player to the 2ND CD IN jacks of this player.
- When connecting a second CD player, do not connect the DIGITAL OUT (OPTICAL) connector of this unit to the amplifier.

Inserting CDs

You can insert up to 300 discs into this player.

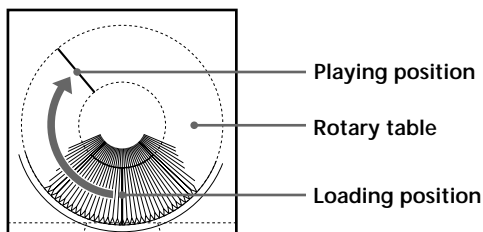
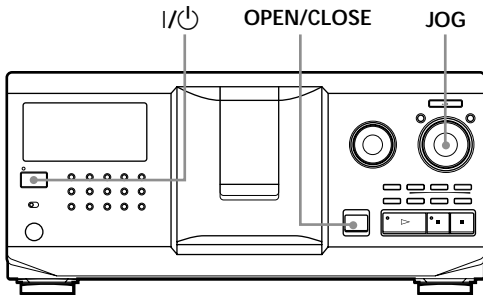

- 1 Press I/⏻ to turn on the player.
- 2 Open the front cover by pressing OPEN/CLOSE.

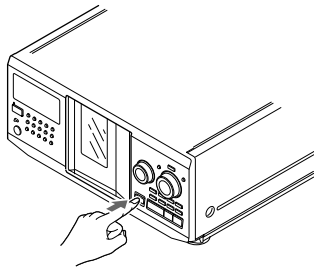

- 3 Turn the JOG dial until you find the disc slot where you want to insert a disc, while checking the disc number (written beside every slot and also indicated in the display).

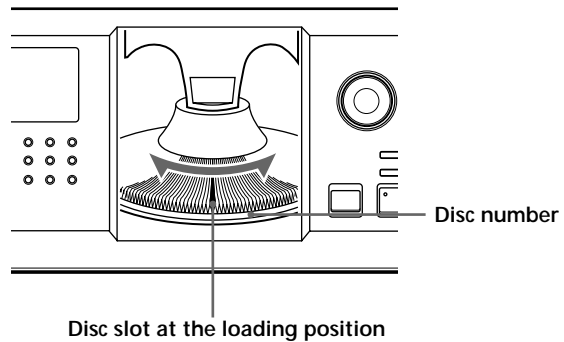

The disc number at the loading position appears in the display. If the disc has the Disc Memo (see page 24), the Disc Memo appears instead of the disc number. As you turn the JOG dial, the disc number or the Disc Memo changes.

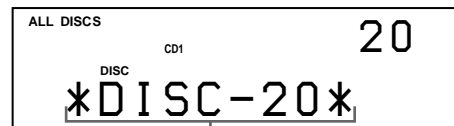

Disc number or the Disc Memo

You can classify discs into eight groups by using the Group File function. This feature lets you easily find the disc you want to play. For details, see "Grouping Discs" on page 28.

(Continued)

Getting Started

- 4 Insert a disc with the label side facing right.

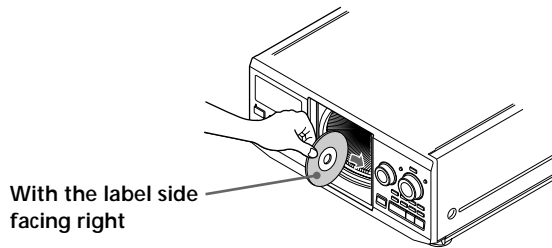

After inserting the disc, you can input the original disc titles instead of the disc numbers (see “Labeling Discs” on page 24) to locate it easily when you start playing.



- 5 Repeat Steps 3 and 4 to insert more discs.
- 6 Close the front cover by pressing OPEN/CLOSE.

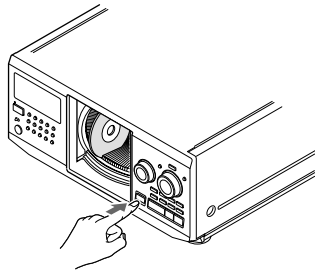

The rotary table turns and the disc slot at the loading position is set to the playing position. Always close the front cover except when you insert or remove discs.

Notes

- Do not insert an empty 8 cm (3-inch) CD adaptor (CSA-8). It may damage the player.
- Do not attach anything such as seals or sleeves to CDs. It may damage the player or the disc.
- If you drop a disc into the player and/or the CD won't go into the slot correctly, consult your nearest Sony dealer.
- When transporting the player, remove all discs from the player.
- Make sure to insert the disc at a right angle to the rotary table, otherwise damage to the player and/or the disc could result. If the disc is not inserted into the slot completely, reinsert the disc.
- Make sure the rotary table comes to a complete stop before inserting or removing discs.
The front panel closes automatically when you press . Be careful not to put your hand into the player after pressing otherwise your hand may be caught in the front panel.

Removing CDs

After following Steps 1 to 3 of “Inserting CDs” on page 7, remove the discs. Then close the front cover.

To remove discs easily

After following steps 1 to 3 of “Inserting CDs” on page 7, press ■ (DISC EJECT). The disc in the selected slot moves up and you can remove the disc easily. When you press ■ again, the disc returns back to the normal position. If the disc does not return back to the normal position, reinsert the disc.

Playing a CD

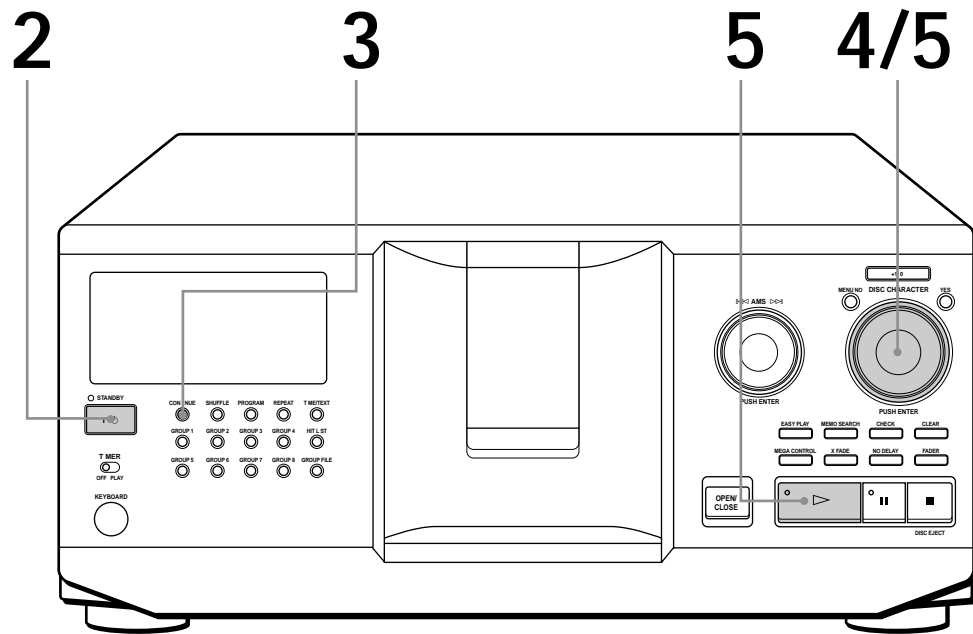

- See pages 4 – 5 for the hookup information.
- Make sure you have inserted the discs correctly as indicated on pages 7 – 8.
- You can play all the tracks on a disc in the original order (Continuous Play). You can also play up to 300 discs consecutively.

💡 You can turn on the player by pressing I/O on the remote 

- 1 Turn on the amplifier and select the CD player position.
- 2 Press I/O to turn on the player.
- 3 Press CONTINUE to select ALL DISCS or 1 DISC Continuous Play mode.
Each time you press CONTINUE, “ALL DISCS” or “1 DISC” appears alternately in the display.

| When you select | The player plays |
|-----------------|--|
| ALL DISCS | All discs in the player consecutively in the order of disc number. Empty disc slots are skipped. |
| 1 DISC | Only one disc you have selected |

- 4 Turn the JOG dial until the disc number or the Disc Memo (see page 24) you want appears in the display to select the first disc (ALL DISCS) or the disc you want (1 DISC).

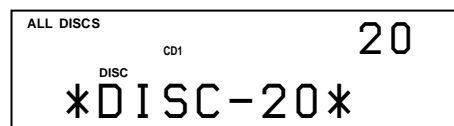



- 5 Push the JOG dial or press ▷ to start playing.
The selected disc is set to the playing position, and the player plays all the discs from the selected one (ALL DISCS) or all the tracks once (1 DISC).
Adjust the volume on the amplifier.

💡 When you turn off the player
The player remembers the last playing disc and the play mode (Continuous, Shuffle, or Program (see pages 17 and 18)). When you turn on the player again, therefore, the player plays the same disc in the same play mode.

To stop playback

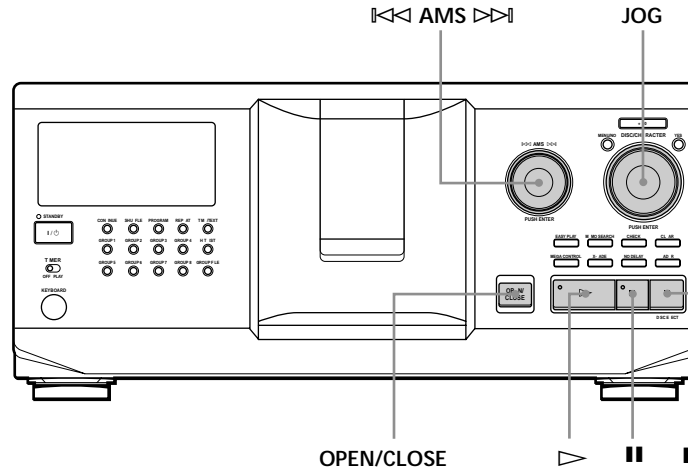
Press ■.



| To | You need to |
|---|--|
| Pause | Press |
| Resume playing after pause | Press or ▷ |
| Go to the next disc  | Press DISC SKIP + once. Hold down the button to skip discs. |
| Go back to the preceding disc  | Press DISC SKIP - once. Hold down the button to skip discs. |
| Go to the next track | Turn the ◀◀ AMS ▶▶ dial clockwise by one click. |
| Go back to the preceding track | Turn the ◀◀ AMS ▶▶ dial counterclockwise by one click. |
| Stop playing and remove the disc | Press OPEN/CLOSE |

Using the Display

You can check information about the disc using the display.

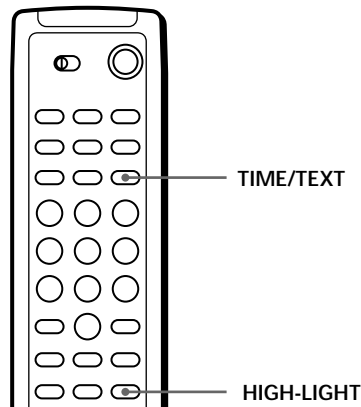
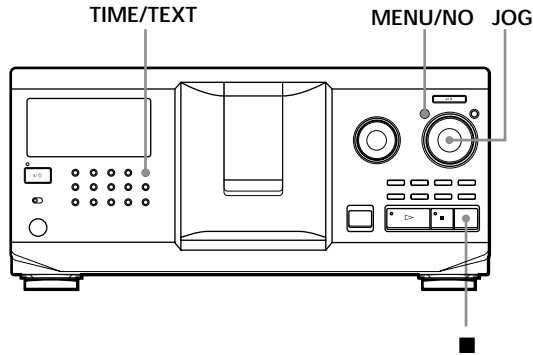

Checking the total number and playing time of the tracks

Select the disc you want to check, and press TIME/TEXT.

The display shows the current disc number, total number of tracks, and total playing time of the disc.

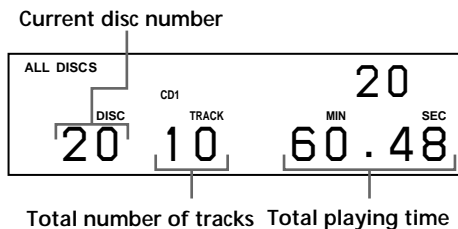

When you want to check another disc

Press DISC SKIP +/- on the remote in the stop mode to select the disc you want to check. The total number of tracks and the total playing time of the selected disc appear momentarily.

Display information while playing a disc

While playing a disc, the display shows the current disc number, track number, playing time of the track and the next disc number.

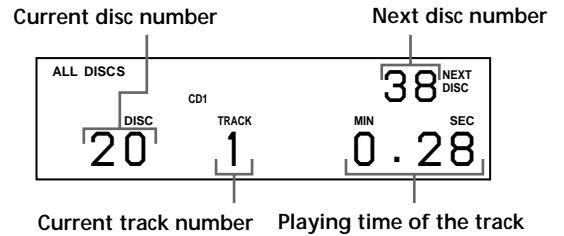

Checking the information of CD TEXT discs

CD TEXT discs have information, such as the disc titles or artist names, memorized in a blank space on the discs where, on normal discs, there is no information. The display shows the CD TEXT information of the disc so that you can check the current disc title, artist name and track title. When the player detects a CD TEXT disc, "CD TEXT" appears in the display. If your CD TEXT disc has multi-language capacity, "MULTI CD TEXT" appears in the display. If you want to check the information in another language, refer to "Selecting the language of the CD TEXT information" on page 13.

Display information in stop mode

The display shows the disc title. When you press TIME/TEXT, the artist name scrolls in the display. If you press TIME/TEXT again, the display shows the current disc number, total number of tracks, and total playing time of the disc momentarily. Then the display shows the disc title again.



Display information while playing a disc

Each time you press TIME/TEXT, the display shows the information as shown below.

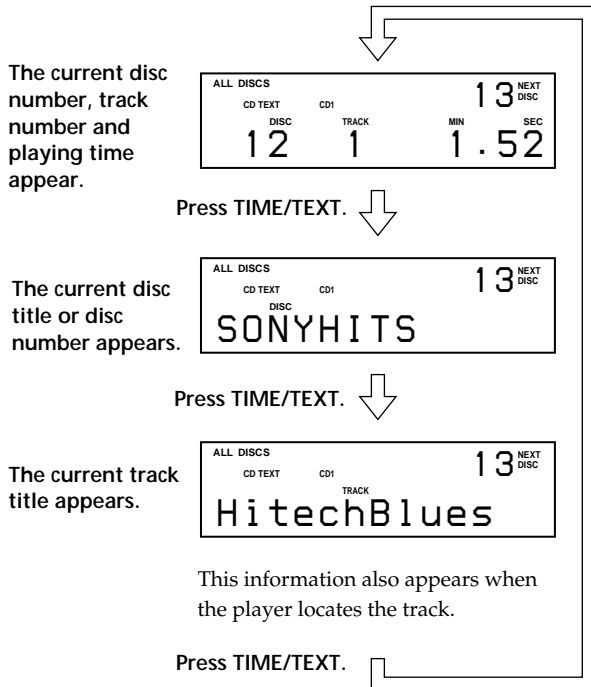

Notes

- If the disc title and track title have more than 13 characters, only the first 13 characters appear in the display.
- The track title appears only when the current disc is a CD TEXT disc or the current title has a HIT TITLE (only when the player is in the Hit List mode) (see page 31).

To play disc highlights

Some CD TEXT discs have a feature to play only the highlights of the discs. During stop mode, press HIGH-LIGHT on the remote to start playing disc highlights. "Hi LIGHT" flashes while playing disc highlights. If you press HIGH-LIGHT while selecting discs without this feature, "NO HIGHLIGHT" appears in the display.

Selecting the language of the CD TEXT information

You can select the language used to display the CD TEXT information when you select a CD TEXT disc with multi-language information. Once you select the language, the display shows the information in the selected language until you turn off the player. If the player cannot read the language memorized in a CD TEXT disc, "other lang." appears.

- 1 Press MENU/NO in stop mode. "Select lang.?" flashes.

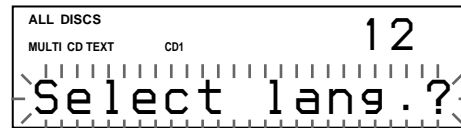

- 2 Push the JOG dial. The current operating language flashes.

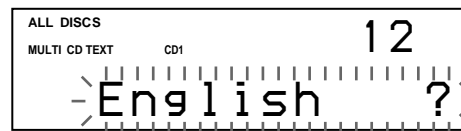

- 3 Turn the JOG dial until the language you want appears in the display.
- 4 Push the JOG dial to select the language. "Reading text" appears momentarily, then the display shows the information in the selected language.

To check the current language

- 1 Press MENU/NO while playing a CD TEXT disc. "Show lang.?" flashes.
- 2 Push the JOG dial. The current language appears momentarily. You can also check the current language while selecting a CD TEXT disc without multi-language information.

Note

If you select a CD TEXT disc which does not contain the information of the selected language, the display shows the information in another language according to the disc's priority.

Locating a Specific Disc

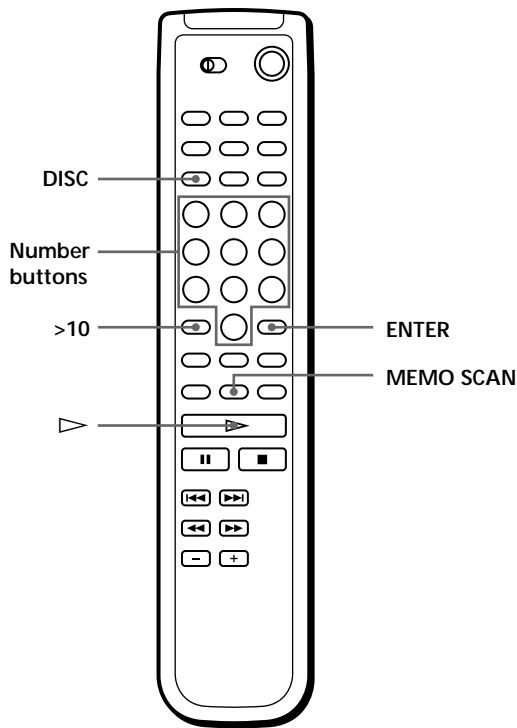
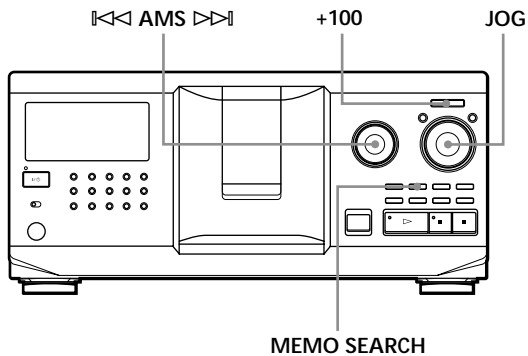

Locating a disc on the player

Turn the JOG dial until the desired disc number or Disc Memo (see page 24) appears in the display. Push the JOG dial to start play.

To skip discs quickly

Press +100. Each time you press +100, the player skips 100 discs.

Locating a disc directly using the remote

- 1 Press DISC.
- 2 Press the number button of the disc.
Example: To enter number 35
Press 3 then 5.
To enter number 100
Press 1, then 10/0 twice.
- 3 Press ENTER to start play.

Locating a disc by scanning each Disc Memo (Memo Scan)

You can locate a desired disc to play quickly by scanning the Disc Memos (see page 24) in the display. Note that you cannot use this function in the ALL DISCS Shuffle Play mode.

- 1 Press MEMO SCAN.
"MEMO SCAN" appears in the display, and the Disc Memos scroll in the display.
- 2 Press  when the Disc Memo of the desired disc to play appears.
The disc is set to the playing position, and the player starts playing.

In Program Play mode, the disc will be added to the end of the program if you press ENTER instead of .

Note

If "NO ENTRY" appears in the display, no disc has been labeled with the Disc Memo. Try the Memo Scan function again after labeling the discs.

Locating a disc searching for a specific Disc Memo (Memo Search)

You can search for and locate a desired disc by the first character of the Disc Memo (see page 24). The Memo Search function can display the Disc Memo in alphabetical order.

- 1 Press MEMO SEARCH.
"MEMO SEARCH" appears in the display.
- 2 Turn the JOG dial to find the desired disc.
As you turn the JOG dial, the Disc Memos starting with the input character appear in the display.



The characters which are displayed as the first character.

A B C D E F G H I J K L M N O P Q R S T U V W X
Y Z 0 1 2 3 4 5 6 7 8 9

If "NOT FOUND" appears in the display while inputting the first character with the ◀◀ AMS ▶▶ dial, no disc has been labeled using the input character.

Notes

- When searching for input characters, blanks and symbols before the first character in the Disc Memo are ignored.
- When searching input characters, upper and lower cases cannot be differentiated.

- 3 Push the JOG dial to select the disc.

In Program Play mode, the disc will be added to the end of the program.

To cancel Memo Search

Press MEMO SEARCH again.

Specifying the Next Disc to Play

You can specify the next disc to play while playing a disc in Continuous or 1 DISC Shuffle Play mode.

While playing a disc, turn the JOG dial. "NEXT DISC" appears in the display and the disc number or Disc Memo (see page 24) changes as you turn the JOG dial. When the desired disc number or Disc Memo appears in the display, stop turning the JOG dial.

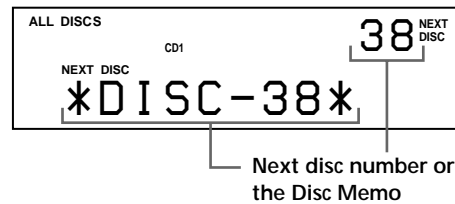

After the current disc is played, the next disc you have specified starts playing.

If you want to skip to the next disc right away, push the JOG dial while playing the current disc.

To cancel the disc you have specified

Press CONTINUE twice.

Playing the Disc Which was Just Inserted – Easy Play

You can play the disc which was just inserted only by pressing one button.

- 1 Open the front cover by pressing OPEN/CLOSE.
- 2 Press EASY PLAY.
Slot 1 moves into loading position.
- 3 Insert the disc in slot 1.
- 4 Press EASY PLAY.
The EASY PLAY button is lit and the player starts playing the disc in slot 1.

Note

The Easy Play function can only play the disc in slot 1.



To cancel the Easy Play function

Press ■.

Locating a Specific Track or a Point in a Track

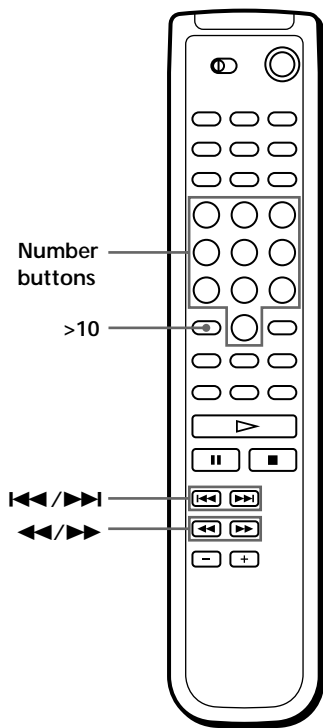
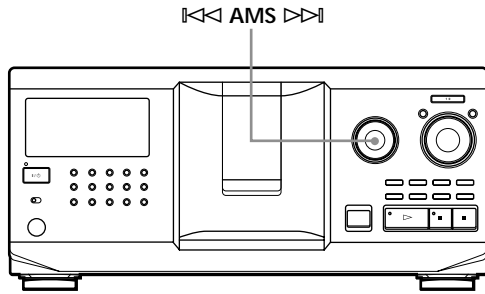
You can quickly locate any track while playing a disc by using the **⏮ AMS ⏭** (AMS: Automatic Music Sensor) dial or by using the **⏮/⏭** buttons on the remote. You can also locate a specific point in a track while playing a disc.



| To locate | You need to |
|---|--|
| the next or succeeding tracks | Turn the ⏮ AMS ⏭ dial clockwise until you find the track |
| the current or preceding tracks | Turn the ⏮ AMS ⏭ dial counterclockwise until you find the track |
| a specific track directly  | Press the number button of the track on the remote. When you directly locate a track numbered over 10, press >10 first, then the corresponding number buttons. |
| a point in a track while monitoring the sound  | Press ⏮ (backward)/ ⏭ (forward) on the remote and hold down until you find the point |
| a point in a track quickly by observing the display  | Press ⏮ (backward)/ ⏭ (forward) on the remote and hold down until you find the point during pause. You will not hear the sound during the operation. |

Note

If “- OVER -” appears in the display, the disc has reached the end while you were pressing **⏭**. Turn the **⏮ AMS ⏭** dial counterclockwise or press **⏮** to go back.

Playing Repeatedly

You can play discs/tracks repeatedly in any play mode.

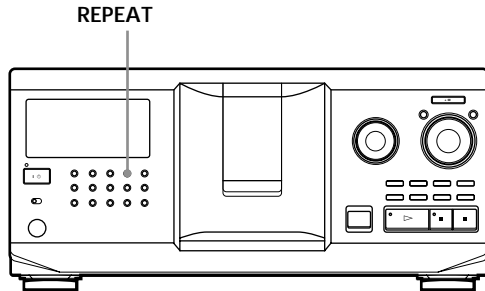

Press REPEAT while playing a disc. "REPEAT" appears in the display. The player repeats the discs/tracks as follows:

| When the disc is played in | The player repeats |
|-------------------------------------|--|
| ALL DISCS Continuous Play (page 10) | All tracks on all discs |
| 1 DISC Continuous Play (page 10) | All tracks on the current disc |
| ALL DISCS Shuffle Play (page 17) | All tracks on all discs in random order |
| 1 DISC Shuffle Play (page 18) | All tracks on the current disc in random order |
| Program Play (page 18) | The same program |

To cancel Repeat Play

Press REPEAT twice.

Repeating the current track

You can repeat only the current track.

While the track you want is being played, press REPEAT repeatedly until "REPEAT 1" appears in the display.

To cancel Repeat 1

Press REPEAT.

Playing in Random Order (Shuffle Play)

You can have the player "shuffle" the tracks and play in random order. The player shuffles all the tracks on all discs or on the disc you specify.

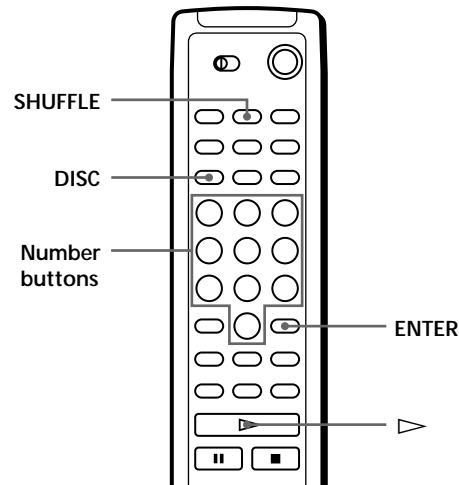
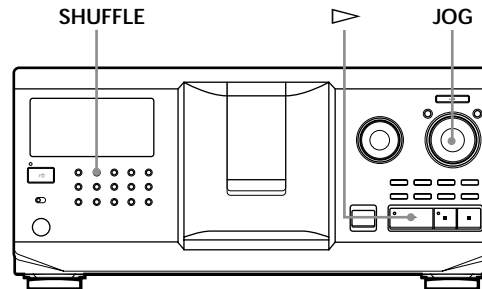

Playing all tracks on all discs in random order







- 1 Press SHUFFLE. "ALL DISCS" and "SHUFFLE" appear in the display.
- 2 Push the JOG dial or press . ALL DISCS Shuffle Play starts. "⌂" appears in the display while the player is "shuffling" the discs or the tracks.

Playing all tracks on a specified disc in random order

- 1 Press SHUFFLE twice.
"1 DISC" and "SHUFFLE" appear in the display.
- 2 Turn the JOG dial until the desired disc number appears in the display.
When using the remote, press DISC first and then press the number button of the disc.
- 3 Push the JOG dial or press ▷.
When using the remote, press ENTER.
1 DISC Shuffle Play starts.
"◻" appears in the display while the player is "shuffling" the tracks.

To cancel Shuffle Play

Press CONTINUE.

-  **You can start Shuffle Play while playing**
Press SHUFFLE, and Shuffle Play starts from the current track.
-  **You can directly select a disc for 1 DISC Shuffle Play** 
See "Locating a disc directly using the remote" on page 14.
-  **You can go to the next disc during 1 DISC Shuffle Play** 
Press DISC SKIP +.
-  **You can specify the next disc to play during 1 DISC Shuffle Play**
Turn the JOG dial to specify the next disc. After all the tracks on the current disc are played in random order, the next disc starts playing. If you want to skip to the next disc right away, push the JOG dial while playing the current disc.

Notes

- You cannot specify the next disc to play during ALL DISCS Shuffle Play.
- Even if you press ■ or turn off the player during ALL DISCS Shuffle Play, the player remembers which discs or tracks were played and which were not. Therefore, if you want to start ALL DISCS Shuffle Play again from the beginning, be sure to repeat the procedure from Step 1.

Creating Your Own Program (Program Play)

You can arrange the order of the tracks and/or discs to create three different programs which are stored automatically. A program can contain up to 32 "steps"; one "step" may contain a track or a whole disc. You can make programs using the controls on the remote as well as ones on the player. However, the programming procedures are different.

Creating a program on the player

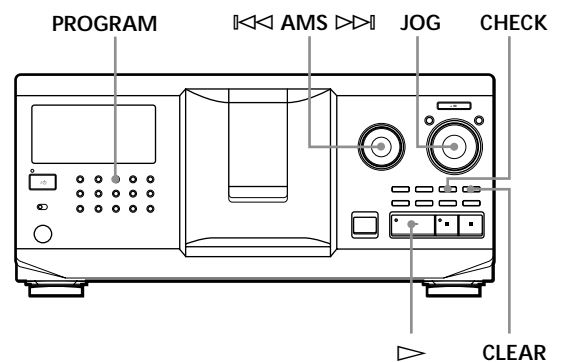

- 1 Press PROGRAM until the desired program number (PROGRAM 1, 2, or 3) appears in the display.
If a program is already stored in the selected program number, the last step of the program appears in the display. When you want to erase the whole program, hold down CLEAR until "CLEAR" appears in the display (see page 20).
- 2 Turn the JOG dial until the disc number you want appears in the display.

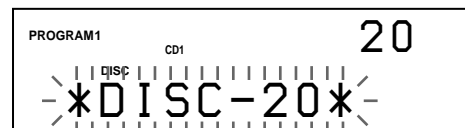

- 3 To program a whole disc, skip this step.
Turn the $||\ll\ll\ll\ll\ll\gg\gg\gg\gg\gg||$ dial until the desired track number appears in the display.

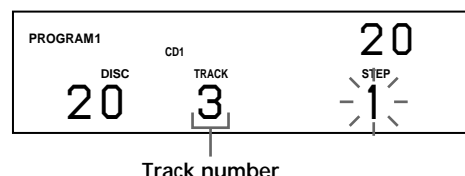

4 Push the JOG dial.

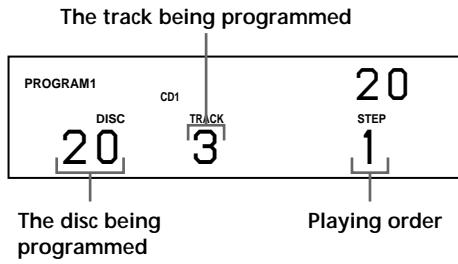

5 To program other discs/tracks, do the following:

| To program | Repeat Steps |
|-------------------------------|--------------|
| All tracks of another disc(s) | 2 and 4 |
| Other tracks on the same disc | 3 and 4 |
| Other tracks on other discs | 2 to 4 |

6 Push the JOG dial or press ▷ to start Program Play.

To cancel Program Play

Press CONTINUE.

The programs remain even after Program Play ends
When you push the JOG dial or press ▷, you can play the same program again.

When you press PROGRAM to select Program Play during Continuous or Shuffle Play
The program will be played after the current track.

The program remains until erased
Even if you replace discs, the programmed disc and track numbers remain. Therefore, the player will play the new existing disc and track numbers. However, the programmed disc and track numbers that are not found in the player or on the disc are deleted from the program, and the rest of the program is played in the programmed order.

Note

If you press one of the GROUP 1 – 8 buttons to start Group Play, Program Play will be canceled (see page 29).

Creating a program using the remote

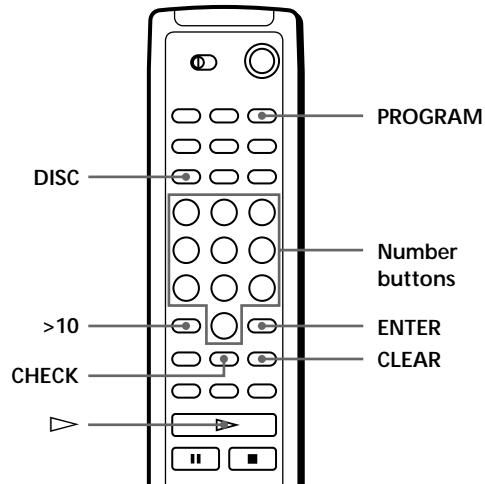

1 Press PROGRAM until the program number you want (PROGRAM 1, 2, or 3) appears in the display.

2 Press DISC.

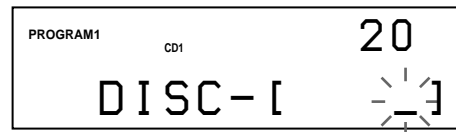

3 Press the number button of the disc.



4 To program a whole disc, press ENTER and go to Step 6.
Press >10.

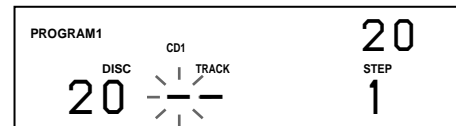

5 Press the number button of the track.
When the disc has more than 10 tracks, press 0 first then press the corresponding number to enter a track number from 1 to 9.

The disc being programmed

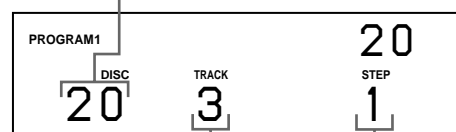

The track being programmed Playing order

(Continued)

6 To program other discs/tracks, do the following:

| To program | Repeat Steps |
|-------------------------------|--------------|
| All tracks of another disc(s) | 2 to 4 |
| Other tracks on the same disc | 5 |
| Other tracks on other discs | 2 to 5 |

7 Press ▷ to start Program Play.

To cancel Program Play

Press CONTINUE.

Checking the programmed order

You can check your program before or after you start playing.

Press CHECK.

Each time you press this button, the display shows the disc and track number of each step in the programmed order. (When a whole disc is programmed as one step, "ALL" appears instead of the track number.) After the last step in the program, the display shows "- END -" and returns to the original display.

Changing the programmed order

You can change your program before you start playing.

| To | You need to |
|---|--|
| Erase a track or disc | Press CHECK until the track or disc you do not want appears in the display, then press CLEAR |
| Erase the last track or disc in the program | Press CLEAR. Each time you press the button, the last programmed track or disc will be cleared. |
| Add tracks or discs to the end of the program | Follow the programming procedure |
| Change the whole program completely | Hold down CLEAR until "CLEAR" appears in the display to erase the whole program, then create a new program following the programming procedure |

Erasing the program stored in memory

- 1 Press PROGRAM repeatedly in the stop mode until the program number (PROGRAM 1, 2, or 3) you want to erase appears in the display.
- 2 Hold down CLEAR until "CLEAR" appears in the display.

Playing Using a Timer

You can start playing a disc at any given time by connecting a timer (not supplied). Refer also to the instructions for the timer if you need help.

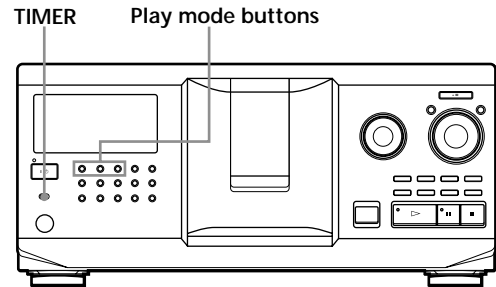

- 1 Press one of the play mode buttons to select the desired play mode.
- 2 Set TIMER on the player to PLAY.
- 3 Set the timer to the desired time. The player turns off. When the set time comes, the player turns on and starts playing.
- 4 After you have used the timer, set TIMER on the player to OFF.

Loading the Disc Memos of the second CD player

If the second CD player has the Disc Memo function (see page 24), you can load the Disc Memos of the second CD player into this player's memory and display them on this player.

- 1 Press MENU/NO.
- 2 Turn the JOG dial until "LOAD 2ndMEMO?" flashes in the display.

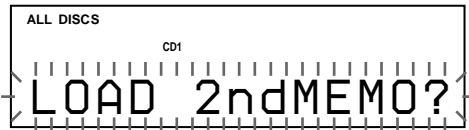

- 3 Push the JOG dial.
This player starts loading. (Loading takes about one minute.)

Note

If each Disc Memo of the second CD player has more than 13 characters, only the first 13 characters of that Disc Memo is loaded into this player.

Labeling discs of the second CD player

You can label discs of the second CD player or change the Disc Memos loaded from the second CD player.

- 1 Press MEGA CONTROL.
The MEGA CONTROL button lights up.
- 2 Turn the JOG dial to select the disc you want to assign a Disc Memo to.
If the disc slot you select does not have any disc, "NO DISC" appears in the display and you cannot assign a Disc Memo.
- 3 Press MENU/NO.
"MEMO IN ?" appears.
- 4 Push the JOG dial.
- 5 Input the new Disc Memo following the procedure in "Labeling Discs" on page 24.

Note

The new Disc Memos are stored on this player's memory, so you cannot display them on the second CD player.

Fading In or Out

You can manually fade the sound in or out to prevent tracks from starting or ending abruptly.

Note that you cannot use this effect when you use the DIGITAL OUT (OPTICAL) connector.

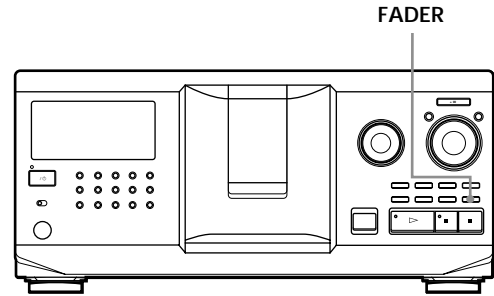

| To | Press FADER |
|----------------------|--|
| Start play fading in | During pause. "FADE" appears in the display and the ◀ indication flashes. The play fades in. |
| End play fading out | When you want to start fading out. "FADE" appears in the display and the ▶ indication flashes. The play fades out and the player pauses. |

Note

Fading lasts for about 5 seconds.

Playing Alternately (No-Delay Play/X-Fade Play)

When you connect the second player, you can play tracks in this player and those from the second player alternately from any play mode (see "Connecting Another CD Player" on page 6).

Select one of the following methods:

- **No-Delay Play:** The current player changes at each track. Each time the current player changes to the other player, the other player starts play without a break in sound immediately after the current player ends play. The other player skips the lead-in portion and starts playing from where the sound actually begins.
- **X-Fade Play:** The current player changes at each track or at the specified interval. You can select the interval, 30, 60 or 90 seconds. Each time the current player changes to the other player, the sound from both players is mixed. The current player ends play by fading out, and the other player starts play by fading in.

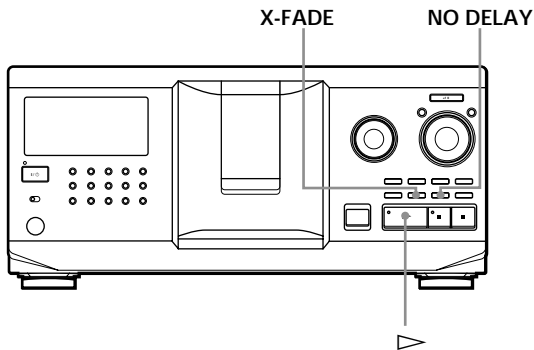

1 Select the play mode you want on each player.

2 When you select No-Delay Play

Press NO DELAY.

"NO DELAY" appears in the display.

When you select X-Fade Play

Press X-FADE.

"X-FADE" appears in the display.

Each time you press the X-FADE button, the indication appears as follows:

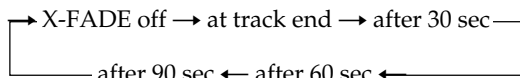

To change the current player each time a whole track is finished, select "at track end."

To change the current player at the specified interval, press X-FADE repeatedly until the interval you want appears in the display.

- 3** Press \blacktriangleright to start playing.
The MEGA CONTROL button lights up while the track in the second player is selected.

To cancel No-Delay/X-Fade Play

Press the corresponding button repeatedly until "NO DELAY" or "X-FADE" disappears from the display. The current player continues playing.

You can change the method (No-Delay or X-Fade) during play

Press the corresponding button (NO DELAY or X-FADE) following the procedure in Step 2.

You can start X-Fade at any point of the track

Press FADER during X-Fade Play.

Even after you have set the X-Fade mode and started X-Fade play, you can start X-Fade manually at any point you like. Note that you cannot do this operation while the sound from both players is mixed.

Notes

- The play starts from the second player if you start play while the MEGA CONTROL button is lit.
- When one player has played all the discs/tracks in the player ahead of the other player, the play stops.
- Do not use the controls on the second player during No-Delay/X-Fade Play. They may not work correctly.

Controlling the Player by Another Unit

When you connect the player to a Sony MD deck compatible with the Mega Control function or operate a Sony MD deck by using the computer software like "MD Editor," you must set the player as shown below:

- 1** Press MENU/NO.
- 2** Turn the JOG dial until "CONTROL A1 ?" appears in the display window.
- 3** Press YES.

To return to normal setting

After following steps 1 and 2, and "CONTROL A1 II ?" is displayed, then press YES.

Notes

- You can perform the operation above correctly only when you operate Disc 1 to Disc 200.
- You cannot operate this player correctly from another player which does not have the CONTROL A1 II jack. In this case, operate the other player from this player.

What You Can Do With the Custom Files

The player can store three types of information called “Custom Files” for each disc. Once you have stored Custom Files for a disc, the player automatically recalls what you have stored whenever you select the disc. Note that Custom Files will be erased if you do not use the player for about one month.

You can store this information:

| When you use | You can |
|-----------------------|---|
| Disc Memo (page 24) | Label discs using up to 13 characters |
| Delete Bank (page 28) | Delete unwanted tracks and store only the tracks you want |
| Group File (page 28) | Group discs up to eight groups, to locate them easily |

Where are Custom Files stored?

Custom Files are stored not on the disc, but in the player’s memory. Therefore you cannot use Custom Files when you play the disc on other players.

If you replace discs you have filed in the Custom Files

The Custom File information you have stored remains, since each Custom File information is assigned to each slot. Erase all the Custom Files (Disc Memo, Delete Bank, and Group File) of the old disc, and then file the new disc information in the Custom Files.

Erasing all Custom Files of all discs

Turn off the player. While holding down CLEAR, press I/⏻ to turn on the player. “ALL ERASE” appears in the display, and all Custom Files will be erased.

Labeling Discs (Disc Memo)

You can label discs using up to 13 characters and have the player display the Disc Memo each time you select the disc. The Disc Memo can be anything you like, such as a title, musician’s name, category, or date of purchase.

💡 When you select a CD TEXT disc

The disc title is automatically stored as the Disc Memo. If the disc title has more than 13 characters, only the first 13 characters of the disc title are stored (see page 13). When you replace a disc with a CD TEXT disc, the disc title of the CD TEXT disc is also stored automatically. Note that you cannot change the Disc Memo of the CD TEXT disc.

💡 You can label discs while the front cover is open

Labeling discs on the player

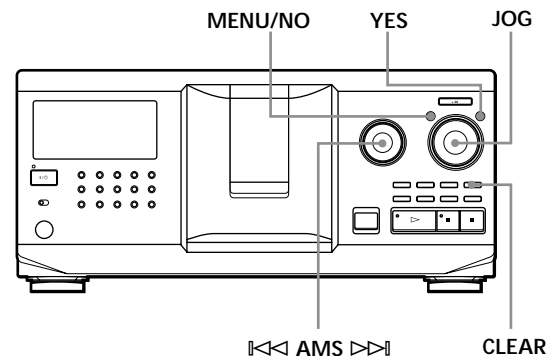

- 1 Turn the JOG dial until the disc number to which you want to assign a Disc Memo appears in the display.
When you label a disc with the front cover closed, the disc number of the disc at the playing position appears.
When you label a disc with the front cover open, the disc number at the loading position appears.
- 2 Press MENU/NO.
“MEMO IN ?” flashes.
- 3 Push the JOG dial.
The flashing cursor (**␣**) appears.

- 4** Turn the JOG dial until the desired character appears in the display. The cursor disappears and the first space for the Disc Memo flashes. As you turn the JOG dial clockwise, the characters appear in the following order. Turn the JOG dial counterclockwise to go in reverse order.

(space) A B C D E F G H I J K L M N O P Q R S T U
 V W X Y Z a b c d e f g h i j k l m n o p q r s t u v w
 x y z 0 1 2 3 4 5 6 7 8 9 ! " # \$ % & ' () * + , - . / : ; <
 = > ? @ _



- 5** Push the JOG dial to select the character. The selected character lights up, and the flashing cursor appears to indicate the next space to be input.

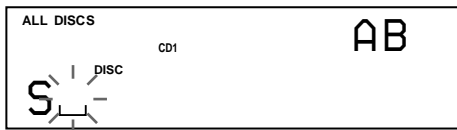

To make a correction

Press CLEAR and begin again by inputting the correct characters.

- 6** Repeat Steps 4 and 5 to input more characters.
7 Press YES to store the Disc Memo. The display shows the Disc Memo.



Repeat Steps 1 to 7 to assign Disc Memos to other discs.

To change the character type quickly while input characters

Press TIME/TEXT in step 4 above. The character on the cursor changes to the first character of each character type. Each time you press TIME/TEXT, the character type changes as follows:

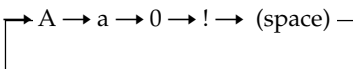

Changing the Disc Memo

- Follow Steps 1 to 3 in "Labeling discs on the player" on page 24 to select the Disc Memo you want to change.
- Turn the ◀◀ AMS ▶▶ dial to move the cursor to the position you want to change. When the cursor position is on a character, the character flashes but when the cursor position is on a blank space, the cursor (_) appears in the display.

To change characters

Turn the JOG dial until the desired character appears in the display.

To add characters

Push the JOG dial. The new blank space appears next to the selected character, then turn the JOG dial until the desired character appears in the display.

To erase characters

Press CLEAR. The selected character disappears.

To erase all characters for the current Disc Memo

Press and hold CLEAR for few seconds. All input characters for the current Disc Memo are erased.

- Repeat step 2 to change more characters.
- Press YES to store the Disc Memo.

Erasing the Disc Memo

- Follow Steps 1 to 3 in "Labeling discs on the player" on page 24 to select the Disc Memo you want to erase.
- Press and hold CLEAR for few seconds.
- Press YES. The Disc Memo disappears.

Storing Information About CDs (Custom Files)

Labeling discs using the remote

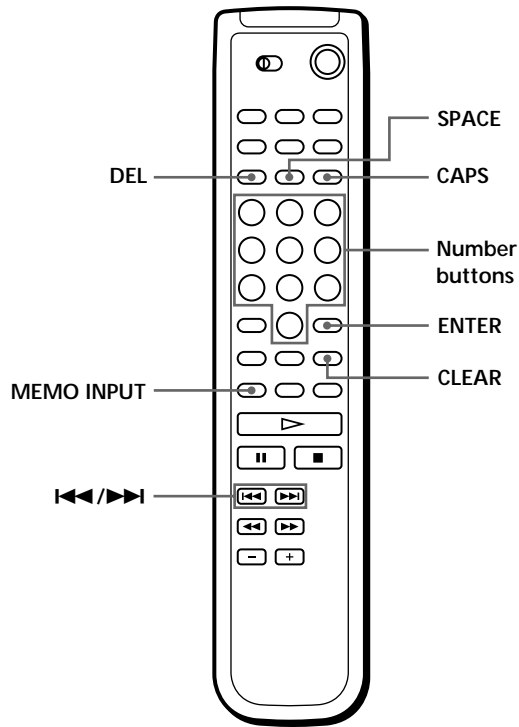

- 1 Press CAPS.
- 2 Press the number button of the disc you want to assign a Disc Memo, and then ENTER.
- 3 Press MEMO INPUT.
The flashing cursor () appears.
- 4 Press CAPS to find the letter type you want. Each time you press the button, the letter type changes cyclically among capital letters (AB), small letters (ab) and numbers (12). To select a symbol, you have to select the capital or small letter type. The selected letter type appears in the upper right of the display.

- 5 To input a letter, press the number button corresponding to the letter you want (indicated beside each number button). The cursor disappears and the first space for the Disc Memo flashes. Each time you press the button, the letter changes cyclically among the ones indicated beside the button.

To input symbols, press the number button 1 repeatedly until the symbol you want appears in the display.

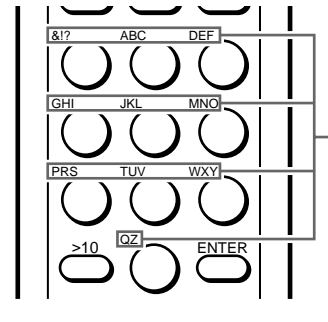

Characters assigned to each number button

Example: To select the letter E
Press the number button 3 twice.

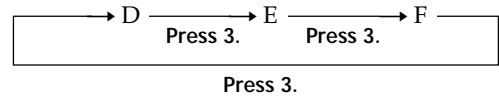

To insert a space, press SPACE once.

To input a number press the number button you want.

- 6 Press ENTER to select the character. The selected character lights up, and the flashing cursor appears to indicate the next space to be input. You can also go to the next space by pressing other number buttons.
- 7 Repeat Steps 4 through 6 to input more characters.
- 8 Press MEMO INPUT to store the Disc Memo. The Disc Memo lights up in the display.



Repeat Steps 1 through 8 to assign Disc Memos to other discs.

💡 If you have made a mistake while inputting the character(s)

To correct the character which has been input

- 1 Press **◀** or **▶** until the cursor moves next to the incorrect character.

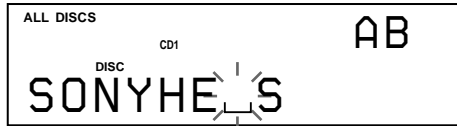

- 2 Press DEL to delete the incorrect character.

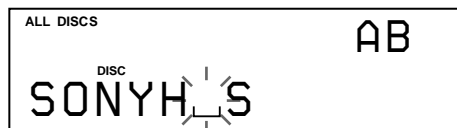

- 3 Input the correct character.



To correct the character currently being input

- 1 Press DEL to delete the incorrect character.
- 2 Input the correct character.

To insert a character between the input characters

Press **◀** or **▶** until the cursor moves next to the point you want to insert, and enter the character.

💡 You can label discs of the second CD player
See "Labeling discs of the second CD player" on page 22.

Storing Custom File Information Using a Keyboard

You can store the Disc Memo for one disc sequentially using an IBM-compatible PC keyboard* (not supplied).

* Power consumption must be 120 mA or less.

Keyboard jack

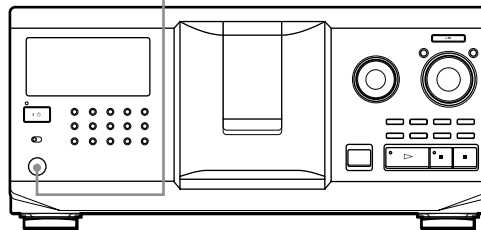

- 1 Connect a keyboard to the keyboard jack on the front panel of the player.

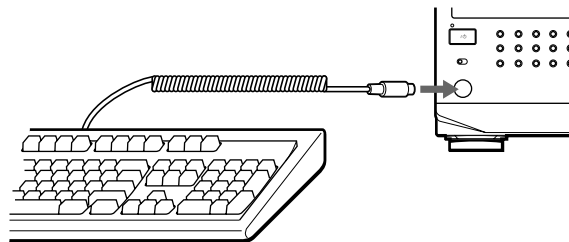

- 2 After selecting the disc you want on the player, press the Enter key.
- 3 Input the characters you want, then press the Enter key to store the information.

💡 You can delete all characters of selected item

While holding down the Shift key, press the Delete key.

Notes

- If the cursor keys do not work correctly and you cannot complete the task using the keyboard, disconnect the keyboard then reconnect it to the player and try again.
- If the keyboard is not the USA model, the characters may be input differently from those on the keys. The USA keyboard layout is shown below.

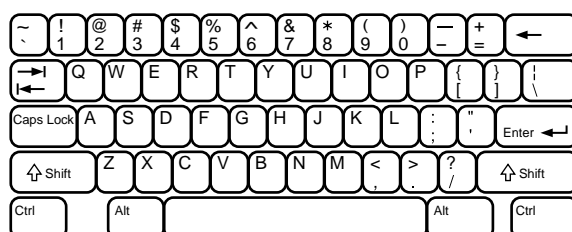

Storing Specific Tracks (Delete Bank)

You can delete unwanted tracks and store only the tracks you want. When you select the disc containing a Delete Bank, the player will play only the remaining tracks.

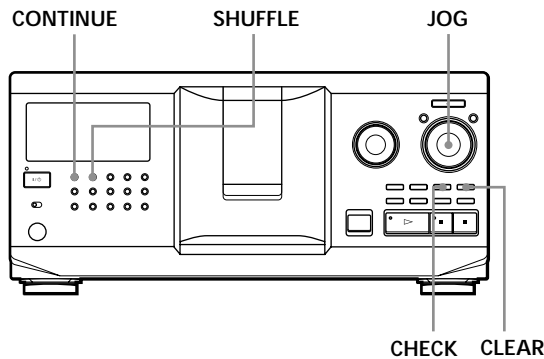

- 1 Press CONTINUE or SHUFFLE before you start playing.
- 2 Turn the JOG dial to select the disc.
- 3 Press CHECK repeatedly until the track you want to delete appears in the display.

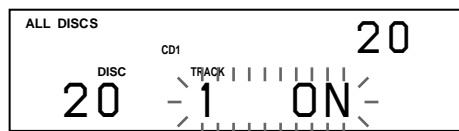

- 4 Press CLEAR. "DELETE FILE" and "OFF" appear in the display.

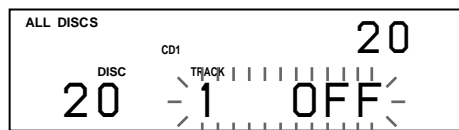

If you want to recover the track, press CLEAR again.

- 5 Repeat Steps 3 and 4 to delete more tracks.

💡 You can recover all the tracks you have deleted
Hold down CLEAR until "ALL ON" appears in the display.

Note

The deleted tracks are skipped even in the Shuffle or Program Play mode (when the whole disc containing a Delete Bank is programmed as one step).

Grouping Discs (Group File)

You might find that too many discs make it hard to find the disc you want. This player has a feature that lets you classify discs into eight groups. One disc can be put into only one group.

Once you classify discs, you can enjoy Continuous, Shuffle, or Repeat Play within a certain group (Group Play).

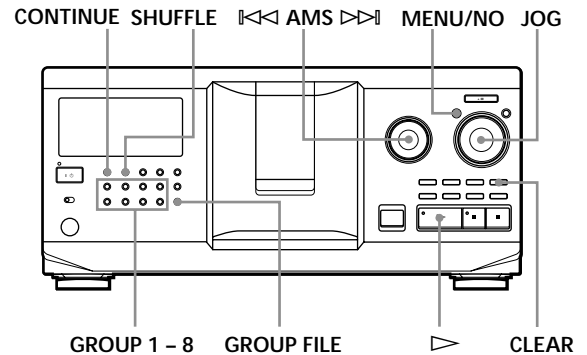

Assigning discs to groups

- 1 Press CONTINUE or SHUFFLE before you start playing.
- 2 Turn the JOG dial to select the disc you want to assign to a group.
- 3 Press GROUP FILE. "Select G1 - G8" appears in the display.
- 4 Press one of the GROUP 1 - 8 buttons to which you want to assign the disc. "GROUP FILE" and the group number appear in the display and the disc is assigned to that group.

Deleting discs from a group

- To delete a disc from a group
 - 1 Turn the JOG dial until the disc number you want to delete from the group appears in the display.
 - 2 Press GROUP FILE. "Select G1 - G8" appears in the display.
 - 3 Press CLEAR. "GROUP ERASE" appears in the display.
- To delete all discs from a group, press CLEAR while holding down whichever GROUP 1 - 8 button you want to clear.

Labeling groups (Group Memo)

You can label the preset group number anything you like, such as a category, using up to 13 characters. Note that you cannot store the Group Memo if you have not assigned any disc to the group.

- 1 Press MENU/NO. "MEMO IN ?" flashes.
- 2 Turn the JOG dial until the group number you want to label appears in the display, and then push the JOG dial. The flashing cursor (**␣**) appears.
- 3 Turn the JOG dial until the desired character appears in the display. The cursor disappears and the first space for the Group Memo flashes. As you turn the JOG dial clockwise, the characters appear in the following order. Turn the JOG dial counterclockwise to go in reverse order.

(space) A B C D E F G H I J K L M N O P Q R S T U
 V W X Y Z a b c d e f g h i j k l m n o p q r s t u v w
 x y z 0 1 2 3 4 5 6 7 8 9 ! " # \$ % & ' () * + , - . / : ; <
 = > ? @ _

- 4 Push the JOG dial to select the character. The selected character lights up, and the flashing cursor appears to indicate the next space to be input.

To make a correction
 Press CLEAR and begin again by inputting the correct characters.
- 5 Repeat Steps 3 and 4 to input more characters. See also "Labeling discs on the player" on page 24 for details.
- 6 Press YES to store the Group Memo.

Changing the Group Memo

- 1 Follow Steps 1 and 2 in "Labeling groups" to select the Group Memo you want to change.

- 2 Turn the **◀◀ AMS ▶▶** dial to move the cursor to the position you want to change. When the cursor position is on the character, the character flashes and the cursor position is on the blank space, the cursor (**␣**) appears in the display.

To change characters

Turn the JOG dial until the desired character appears in the display.

To add characters

Push the JOG dial. The new blank space appears next to the selected character, then turn the JOG dial until the desired character appears in the display.

To erase characters

Press CLEAR. The selected character disappears.

- 3 Repeat step 2 to change more characters.
- 4 Press YES to store the Group Memo.

Erasing the Group Memo

- 1 Follow Steps 1 and 2 in "Labeling groups" on page 29 to select the Group Memo you want to erase.
- 2 Press and hold CLEAR for few seconds.
- 3 Press YES. The Group Memo disappears.

Playing discs in a group on the player (Group Play)

You can enjoy Continuous or Shuffle Play within a group.

- 1 Select the play mode you want before you start playing.

| When you select | The player plays |
|---------------------------|---|
| ALL DISCS Continuous Play | All tracks on all discs in the group consecutively |
| 1 DISC Continuous Play | All tracks on the specified disc in the group consecutively |
| ALL DISCS Shuffle Play | All tracks on all discs in the group in random order |
| 1 DISC Shuffle Play | All tracks on the specified disc in the group in random order |

(Continued)

Storing Information About CDs (Custom Files)

- 2 Press one of the GROUP 1 – 8 buttons to select the group and press ▷.
Group Play starts from the disc which is the most upward number and located closest to the playing position. If the disc at the playing position is put into the selected group, the play starts from that disc.

To cancel Group Play

Press one of the GROUP 1 – 8 buttons you have selected. "GROUP OFF" appears in the display.

💡 You can start Group Play with the remote

- 1 Before you start playing, press GROUP.
 - 2 Press the number button of the group you want to play, then press ENTER.
 - 3 Press ▷.
- To cancel Group Play, press GROUP.

💡 You can specify the disc to play when starting Group Play

After selecting the group, turn the JOG dial to select the disc, then push the JOG dial or press ▷.
When using the remote, press DISC SKIP repeatedly until the disc number you want appears in the display, then press ENTER.

Note

If "NO ENTRY" appears in the display, no disc has been put into the selected group.

Locating a disc within a group by scanning each Disc Memo

You can locate a disc you want to play within a specific group quickly by scanning the Disc Memo in the display and then start Group Play.

Note that you cannot use this function in the ALL DISCS Shuffle and Program play mode.

- 1 Press GROUP first, then the number button of the group you want.
- 2 Press ENTER.
The group name appears in the display.
- 3 Press MEMO SCAN.
"MEMO SCAN" appears in the display.
The Disc Memos of the discs in the selected group scroll in the display.

- 4 Press ENTER or ▷ when the Disc Memo of the disc you want appears.
Group Play starts from the selected disc.

💡 You can jump to the next or preceding Disc Memo while scanning

Turn the ◀◀ AMS ▶▶ dial.

Storing Your Favorite Tracks (Hit List)

You can store the tracks you play frequently and select those tracks by checking the track numbers or titles (see page 31) in the Hit List.

You can put up to 32 tracks in the Hit List.

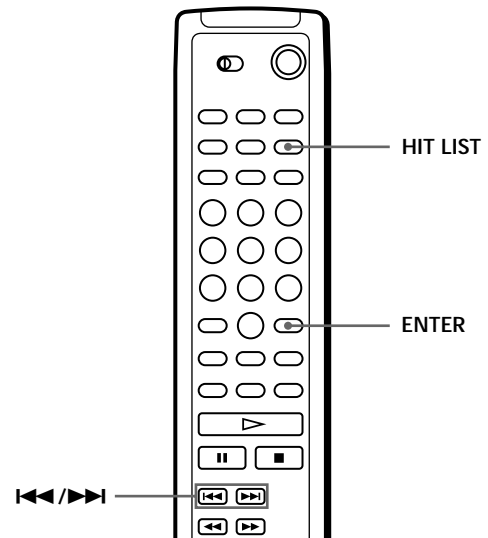
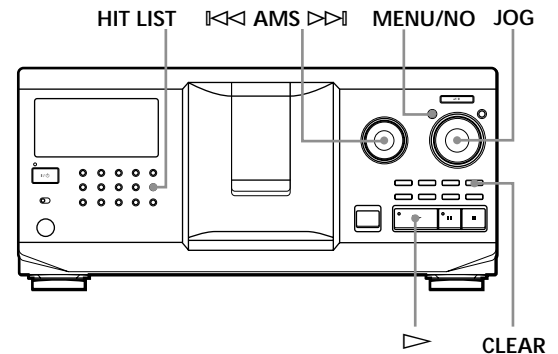

Putting tracks into the Hit List

Press HIT LIST while playing your favorite track. The "HIT" indication and "List in" appear in the display.

Notes

- When you input the 33rd track into the Hit List, the 32nd track will be replaced.
- You cannot store the tracks from a second CD player.

Playing tracks in the Hit List

- 1 Press HIT LIST before you start playing. The HIT LIST button lights up and "HIT LIST" appears in the display.
- 2 Turn the JOG dial or the \lll AMS \ggg dial until the desired track appears in the front panel display.
- 3 Push the JOG dial or press \triangleright to start playing. When using the remote, press ENTER.



The Hit List remains until erased

Even if you replace discs, the Hit List you create remains. Therefore, the player will substitute the new existing tracks into the Hit List.

Note

The track you select in Step 2 will be listed as the first track in the Hit List, and you cannot arrange the order of the tracks in the Hit List.

Deleting tracks from the Hit List

- 1 Follow Steps 1 and 2 in "Playing tracks in the Hit List" on page 31.
- 2 Press CLEAR. The selected track is deleted from the Hit list.

Deleting all tracks of the Hit List

When the HIT LIST button lights up, hold down CLEAR while in stop mode until "CLEAR" appears.

Labeling tracks in the Hit List (Hit Title)

You can label tracks in the Hit List in either of two methods described below.

Labeling tracks while in play mode

- 1 Press MENU/NO while playing a track in the Hit List. "HIT MEMO ?" appears in the display.
- 2 Push the JOG dial. The flashing cursor (\sqcup) appears in the display.

- 3 Turn the JOG dial until the desired character appears in the display. The selected character for the Hit Title flashes. As you turn the JOG dial clockwise, the characters appear in the following order. Turn the JOG dial counterclockwise to go in reverse order.

(space) A B C D E F G H I J K L M N O P Q R S T U
V W X Y Z a b c d e f g h i j k l m n o p q r s t u v w
x y z 0 1 2 3 4 5 6 7 8 9 ! " # \$ % & ' () * + , - . / : ; <
= > ? @ _

- 4 Push the JOG dial to select the character. The selected character lights up, and the flashing cursor appears to indicate the next space to be input.

To make a correction

Press CLEAR and begin again by inputting the correct characters.

- 5 Repeat Steps 3 and 4 to input more characters. See also "Labeling discs on the player" on page 24 for details.
- 6 Press YES to store the Hit Title.

Labeling tracks while in stop mode

- 1 While the HIT LIST button is lit, select the track you want to assign by turning the JOG dial or the \lll AMS \ggg dial.
- 2 Press MENU/NO. The flashing cursor (\sqcup) appears in the display.
- 3 Follow Steps 3 to 6 in "Labeling tracks while in play mode" to input the characters.



You can store a CD TEXT disc's track titles in the Hit List

The CD TEXT disc's track title is stored as a Hit Title automatically when the track is put into the Hit List.

Precautions

On safety

- Caution — The use of optical instruments with this product will increase eye hazard.
- Should any solid object or liquid fall into the cabinet, unplug the player and have it checked by qualified personnel before operating it any further.

On power sources

- Before operating the player, check that the operating voltage of the player is identical with your local power supply. The operating voltage is indicated on the nameplate at the rear of the player.
- The player is not disconnected from the AC power source (mains) as long as it is connected to the wall outlet, even if the player itself has been turned off.
- If you are not going to use the player for a long time, be sure to disconnect the player from the wall outlet. To disconnect the AC power cord (mains lead), grasp the plug itself; never pull the cord.
- AC power cord must be changed only at the qualified service shop.

On placement

- Place the player in a location with adequate ventilation to prevent heat build-up in the player.
- Do not place the player on a soft surface such as a rug that might block the ventilation holes on the bottom.
- Do not place the player in a location near heat sources, or in a place subject to direct sunlight, excessive dust or mechanical shock.

On operation

- If the player is brought directly from a cold to a warm location, or is placed in a very damp room, moisture may condense on the lenses inside the player. Should this occur, the player may not operate properly. In this case, leave the player turned on for about an hour until the moisture evaporates.

On adjusting volume

- Do not turn up the volume while listening to a portion with very low level inputs or no audio signals. If you do, the speakers may be damaged when a peak level portion is played.

On cleaning

- Clean the cabinet, panel and controls with a soft cloth slightly moistened with a mild detergent solution. Do not use any type of abrasive pad, scouring powder or solvent such as alcohol or benzine.

On transportation

- When transporting the player, open the front cover then remove all the discs from the player and turn the power off.

If you have any questions or problems concerning your player, please consult your nearest Sony dealer.

Notes on CDs

On handling CDs

- To keep the disc clean, handle the disc carefully.
- Do not stick paper or tape on the disc.

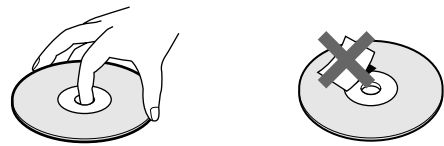

- Do not expose the disc to direct sunlight or heat sources such as hot air ducts, nor leave it in a car parked in direct sunlight as there can be considerable rise in temperature inside the car.
- After removing a disc from the disc slot, store the disc in its case.

On cleaning

- Before playing, clean the disc with a cleaning cloth. Wipe the disc from the center out.

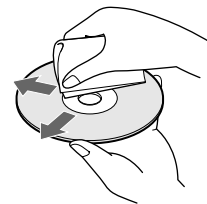

- Do not use solvents such as benzine, thinner, commercially available cleaners or anti-static spray intended for vinyl LPs.

Troubleshooting

If you experience any of the following difficulties while using the player, use this troubleshooting guide to help you remedy the problem. Should any problem persist, consult your nearest Sony dealer.

There is no sound.

- ➔ Check that the player is connected securely.
- ➔ Make sure you operate the amplifier correctly.

The CD does not play.

- ➔ There is no CD in a slot (“-NO DISC-” appears).
Insert a CD.
- ➔ Insert the CD with the label side facing right.
- ➔ Clean the CD (see page 32).
- ➔ Moisture has condensed inside the player. Open the front cover and leave the player turned on for about an hour (see page 32).

The remote does not function.

- ➔ Remove obstacles in the path of the remote and the player.
- ➔ Point the remote at the remote sensor  on the player.
- ➔ Replace all the batteries in the remote with new ones if they are weak.
- ➔ Set the CD 1/2/3 switch on the remote according to the position of the COMMAND MODE selector displayed in the front panel display (see page 5).

The player functions incorrectly.

- ➔ The microcomputer chips may be operating incorrectly. Disconnect the AC power cord, then connect it back to the wall outlet to reset the player.

Specifications

Compact disc player

| | |
|------------------------------|--|
| Laser | Semiconductor laser ($\lambda = 780 \text{ nm}$) Emission duration: continuous |
| Laser output | Max 44.6 μW * * This output is the value measured at a distance of 200 mm from the objective lens surface on the Optical Pick-up block with 7 mm aperture. |
| Frequency response | 20 Hz to 20 kHz $\pm 0.5 \text{ dB}$ |
| Signal-to-noise ratio | More than 107 dB |
| Dynamic range | More than 93 dB |
| Harmonic distortion | Less than 0.0045 % |
| Channel separation | More than 100 dB |

Outputs

| | Jack type | Maximum output level | Load impedance |
|------------------------------|--------------------------|----------------------|---------------------|
| ANALOG OUT | Phono jacks | 2 V (at 50 kilohms) | Over 10 kilohms |
| DIGITAL OUT (OPTICAL) | Optical output connector | -18 dBm | Wave length: 660 nm |

General

| | |
|-------------------------------------|--|
| Power requirements | 120 V AC, 60 Hz |
| Power consumption | 13 W |
| Dimensions (approx.) (w/h/d) | 430 × 189 × 484 mm (17 × 7 1/2 × 19 1/8 in.) incl. projecting parts |
| Mass (approx.) | 8.5 kg (18 lbs 12 oz) |

Supplied accessories

See page 4.

Design and specifications are subject to change without notice.

Index

A, B

- Advanced Mega Control 21
- AMS 16
- Automatic Music Sensor 16

C

- CD TEXT 12
- Changing
 - Disc Memo 25
 - Group Memo 29
- Connecting 4
 - another CD player 6
- Continuous Play 10
- CONTROL A1 II 5
- Custom Files
 - Delete Bank 28
 - Disc Memo 24
 - Group File 28
 - Hit List 30
 - what you can do with 24

D

- Delete Bank 28
- Disc Memo 24

E

- Erasing
 - Custom Files 24
 - Delete Bank 28
 - Disc Memo 25
 - Group Memo 29
 - Hit List 31
 - programs 20

F

- Fading 22

G

- Grouping Discs 28

H

- Handling CDs 32
- Hit List 30
- Hookups
 - overview 4

I

- Inserting CDs 7

J, K

- JOG dial 7

L

- Labeling a disc 24
- Locating
 - a specific point 16
 - a specific track 16
 - by monitoring 16
 - directly 16
 - discs 14
 - using AMS 16

M

- Memo Scan 14
- Memo Search 15

N, O

- No-Delay Play 23

P, Q

- Playback
 - Continuous Play 10
 - Easy Play 15
 - Group Play 29
 - Program Play 18
 - Repeat Play 17
 - Shuffle Play 17
- Program
 - changing 20
 - checking 20
 - erasing 20

R

- Remote control 4
- Repeating 17
- Rotary table 7

S

- Searching. *See* Locating
- Selecting a disc 14
- Selecting the language 13
- Shuffle Play
 - on all discs 17
 - on one disc 18
- Specifying the next disc 15
- Storing
 - information about CDs 24
 - specific tracks 28

T

- Timer Play 20
- Total playing time 12
- Troubleshooting 33

U, V, W

- Unpacking 4

X, Y, Z

- X-Fade Play 23

Names of controls

Buttons

- CAPS 26
- CHECK 20, 28
- CLEAR 18, 28
- CONTINUE 10, 20
- DEL 27
- DISC 14, 19
- DISC SKIP +/- 11
- EASY PLAY 15
- ENTER 14, 19, 31
- GROUP 30
- GROUP 1-8 28
- GROUP FILE 28
- HIGH-LIGHT 13
- HIT LIST 30
- MEGA CONTROL 21
- MEMO INPUT 26
- MEMO SCAN 14
- MEMO SEARCH 15
- MENU/NO 13, 21, 24, 29, 31
- NO DELAY 23
- Number 14, 16
- OPEN/CLOSE 7
- PROGRAM 18
- REPEAT 17
- SHUFFLE 17
- SPACE 26
- TIME/TEXT 12
- X-FADE 23
- YES 25, 29, 31
- ⏮ AMS ⏭ 11
- ▷ 11
- ⏸ 11
- 11
- ⏮/▶ 16
- ◀/▶ 16
- >10 16
- +100 14

Switches

- CD 1/2/3 5
- TIMER 20
- I/⏻ 7

Jacks

- ANALOG OUT 6
- CONTROL A1 II 5
- 2ND CD IN 6

Connectors

- DIGITAL OUT (OPTICAL) 5

Others

- COMMAND MODE selector 5
- Disc slots 7
- Display 12
- Front cover 7
- JOG dial 7
- Rotary table 7
- Ⓜ 4

